

HS-45S Specification

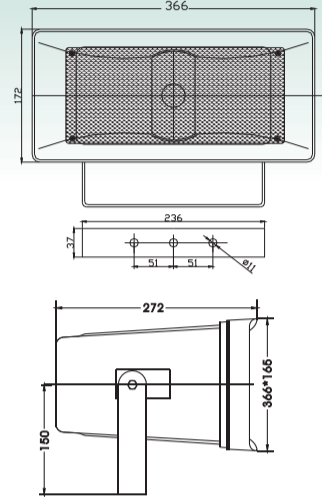

| General Specification | |
|------------------------|-----------------------------------|
| Type | HS-45S |
| Frequency Response | 100-10K HZ |
| SPL | 105dB at 100V 30W |
| Sensitivity | 90±3DB |
| Power Handling | 30W |
| Power taps | 30W/15W/7.5W/3.8W |
| Line input | 100V/70V/8Ω |
| Dimension | 366*165*272 |
| Physical Specification | |
| Material | ABS |
| Component | 5" |
| Finished Colour | French grey |
| Grille | Powder coated Aluminium Mesh |
| Unit Weight | 3Kg |
| Gross Weight | 5kg/1pcs |
| Packing Dimension | 44*24*36CM |
| Speaker Specification | |
| Voice Coil Size | kapton 25.9*0.13*2T |
| DC Impedance | 7.2 Ω |
| Former | Kapton |
| Magnet | Ferrite(305g) φ 80*32*15 (Y30) |
| Basket | Iron |
| Cone Material | Paper |
| Spider | Cloth |
| Dust cap | Mylar |
| Net Weight | 830g |

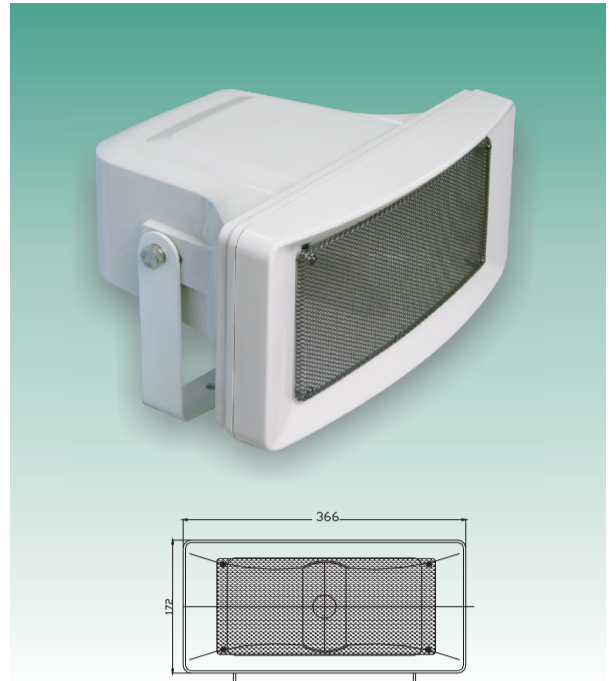

Caution:
Never set the switch to "—" position for 100V or 70V line

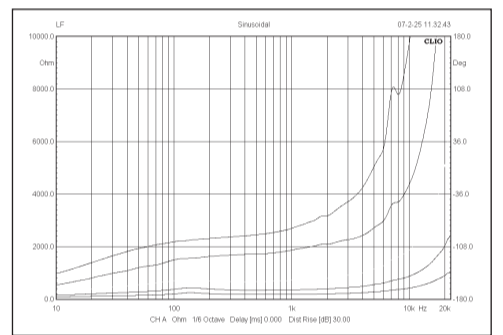
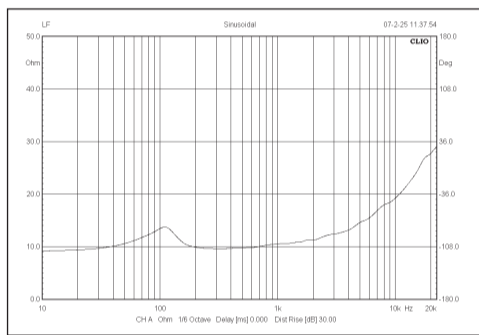
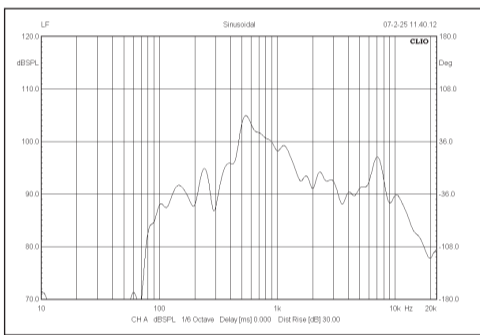

Horizontal:

Vertical:

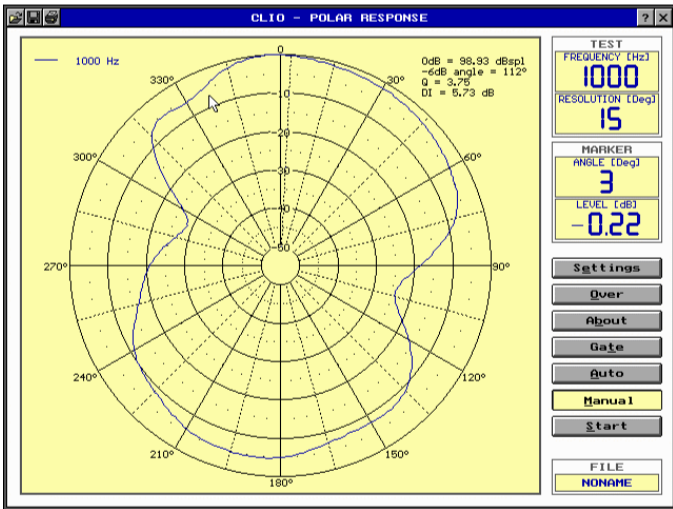

1000Hz

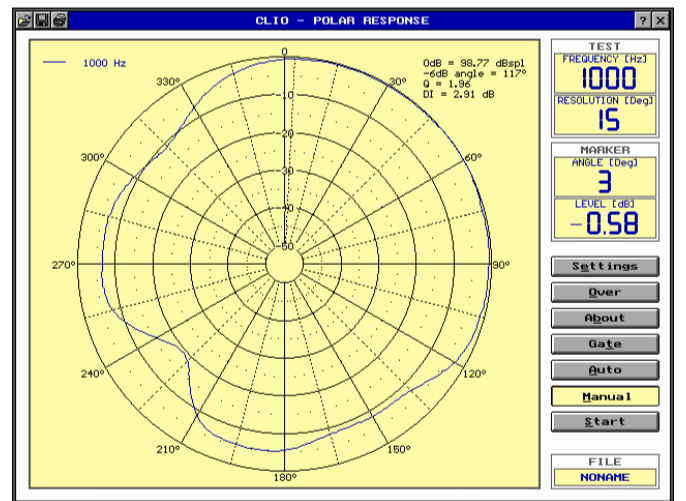

1000Hz (V)

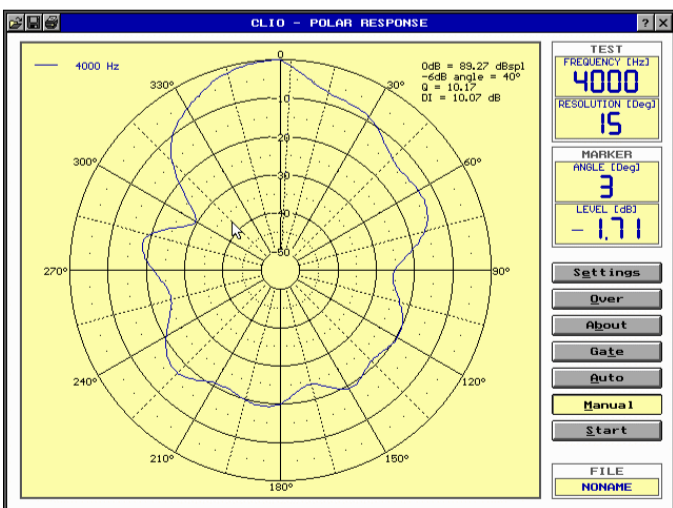

4000Hz

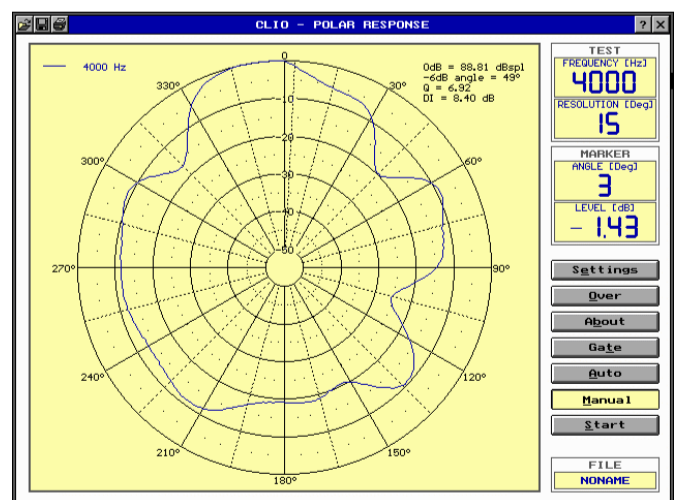

4000Hz

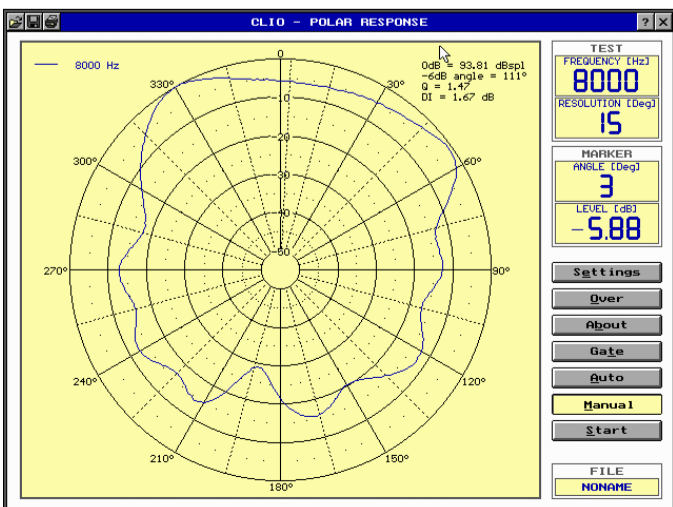

8000Hz

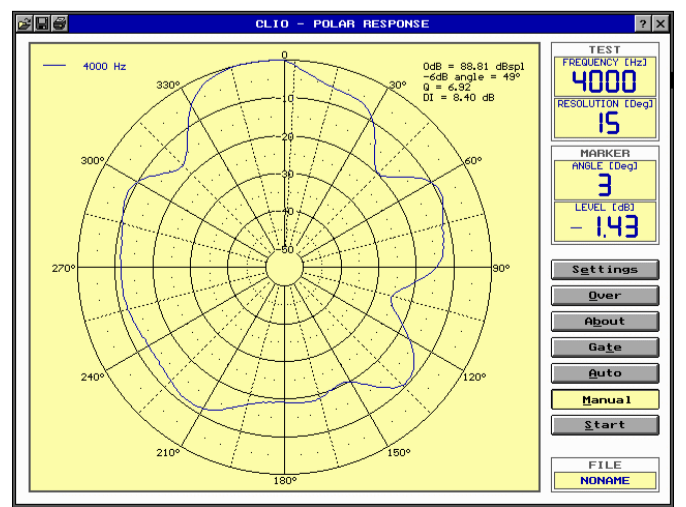

8000Hz